

Using Experimental Procedure to Improve the Efficiency of the Two Stand Reversing Cold Mill

Mohammad Heydari Vini^{1*}

¹Instructor, Department of Engineering, Islamic Azad University, Mobarakeh Branch, Mobarakeh, Isfahan, Iran

*Email of Corresponding Author: m.heydarivini@gmail.com

Received: October 4, 2014; Accepted: December 26, 2014

Abstract

Production of thin steel strips with 0.18-0.26 mm thickness is about 0.75 of annual production of the two stand reversing cold mill, while its efficiency is 60%. This is due to the fact that after montaging the grinded work rolls, rolling thin steel strips (with thicknesses less than 0.18 millimeters) is unavailable. Initially, unsuitable surface roughness, the friction between rolls and the strip and thermal conditions result in the rupturing of steel strips. Usually, cold rolling of several coils of thick steel strips, for example 0.3 -0.5 mm thickness, for the first rolling pass is necessary. This primary preparation reduces the work rolls life and produces unneeded coils. In this study, by experimental investigation, the effective parameters such as lubrication condition, surface roughness of work rolls and their improvement, the possibility of cold thin steel strip rolling is examined. Finally, several methods for improvement the cold rolling efficiency and decreasing the amount of strip rapture in the two stand reversing cold mill are presented.

Keywords

Cold rolling, Work roll texturing, Two stand reversing cold mill, Shot blast

1. Introduction

Cold rolling conditions after replacing the grinded work rolls in rolling stands is different from conditions after rolling several coils in the two stand reversing cold mill. Usually, low ambient temperature influence on the process efficiency and it leads to the rupturing of the thin steel strips. Due to this problem, at the beginning of the rolling process, several coils with higher thicknesses than the desired value are rolled and finally the work rolls are ready to roll thin steel strips. Rolling several coils with higher thicknesses than conventional generates an appropriate surface roughness of work rolls for rolling thinner steel strips. Figure.1 demonstrates the two stand reversing cold mill. In this tandem system, there are 3 passes and each of them has 2 steps in two stands.



Fig. 1. The two stand reversing cold mill

1.1 Effect of lubrication on the rolling process

First of all, after montaging the grinded work rolls into the rolling stands, due to high surface roughness of the strips and rupturing the thin steel strips rolling of thin strips is impossible [1]. So, for starting the rolling process, using rolling lubrications (an emulsion of oil and water) with higher oil-to-water ratio is recommended.

After rolling different coils in the tandem mill and decreasing surface roughness of rolls, the lubricating can be done with a low oil-to-water ratio. Increasing the surface roughness of strips improvesthelubricating condition during the rolling process. According to figure2, by increasing the surface roughness of the strips, the minute particles of lubrication have been trapped in the holes on the surface of the strip, and they enter into the rolling bite and the rolling length has been perfectly lubricated. So, the lubrication has a better role to decrease the shear tensile stresses along the rolling bite.

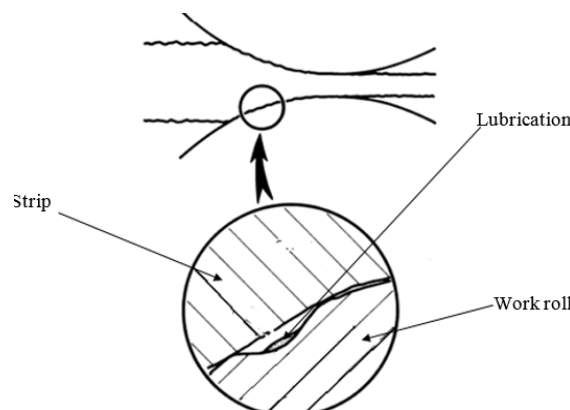

Fig.2. Effect of surface roughness of the rolls and strip on the rolling lubricating

Wiles showed that cold rolling of a hard strip with 0.061 inches thickness and rolls with 21 inches diameter leads to a 9% thickness reduction with a surface roughness of 5-10 micro inches. Also, 32% of thickness reduction generated the 30-40 micro inches of surface roughness of strips [2].Increasing the friction coefficient increases the shear tensile stresses and the rolling force. So, in the beginning of the rolling process in the tandem mill, due to a higher friction coefficient, the rolling force has a higher amount than conventional. The best way to decrease the friction

coefficient is using a rolling lubrication with a higher oil-to-water ratio than conventional according to figure 3. High surface roughness of the work rolls generates an adhesive friction condition which leads to increasing the rolling force. At the final rolling cycles, due to a low primary thickness of the strip before rolling, the generated shear tensile stresses are more destructive.

As can be seen in figure 4, by increasing the rolling cycles, because of an increasing amount in the rolling pressure, the rolling process becomes critical and increasing the amount of lubrication is necessary.

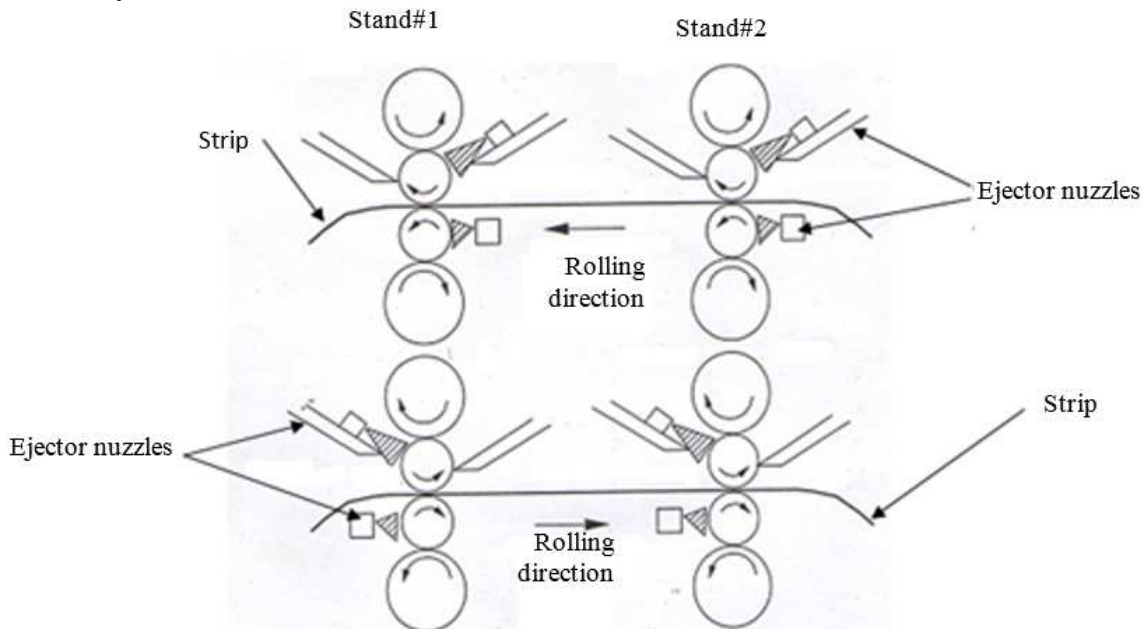

Fig.3. The ejection of lubrication in three reciprocating cycles in the two stand reversing cold mill [3]

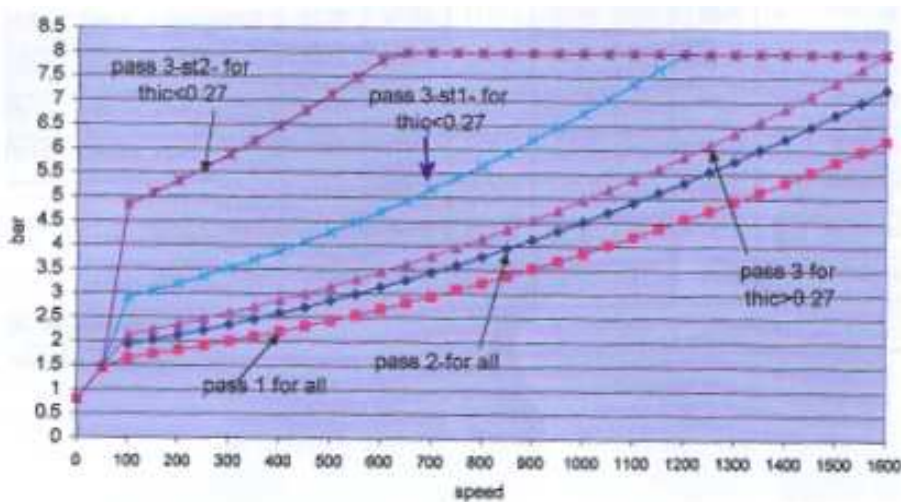

Fig. 4. The ejection diagrams of the rolling lubrication for three cycles in the two stand reversing cold mill

In the multi cycle rolling processes, the critical cycle is the last one [4]. As a result, the rolling lubricating at this stage is considerable. So, an inter stand lubricating system in the two stand tandem mill for cycle#3-stand#2 is recommended. In this stage, due to a high rolling pressure condition, the volume percentage of oil to water is 5-6 %. In conventional rolling processes, the lubrication has lubricating and cooling aspects. This inter stand lubricating system severely

decreases the shear stresses along the rolling bite. Also, this lubricating system decreases the rupturing of the steel strips and improves the efficiency of the cold rolling process [5, 6].

1.2 The effect of the surface roughness of the work rolls

The surface roughness of the work rolls has a considerable effect on the rolling friction [7]. Increasing the surface roughness of the work rolls increases the friction forces during the rolling process. A rough texture of work rolls decreases the efficiency of lubricating, while a rough texture of strip improves it. After rolling several steel coils in the two stand reversing cold mill, the surface roughness of the work rolls gradually decreases and the rolls should be sent to roll shop for grinding. After disassembling the rolls smoothed during the rolling with the new grinded ones, their surface roughness is about 20-30 micro inches. This surface roughness amount reaches to 14-16 micro inches after rolling 10-14 steel coils. Usually, the chatter phenomenon appeared with 10-15 micro inches surface roughness of rolls. The chatter leads to thickness variations in the strips and because the tensile stresses are constant, it can increase the normal stresses in the strip and it ruptures the strip. A rough texture of roll generates an adhesive friction condition along the rolling bite. In an adhesive friction condition, when the shear stresses reach to the yield stress of the strip, the plastic deformation occurs by frictional shear stresses. So, for rolling thin steel strips, the rough work rolls are not recommended.

2- Experiments

2-1 Effect of the surface roughness of the rolls

For investigating the effect of the surface roughness of the work rolls on the rolling process, the output information of four work rolls in the two stand reversing cold mill has been investigated. The results have been summarized according to figures 5 to 9.

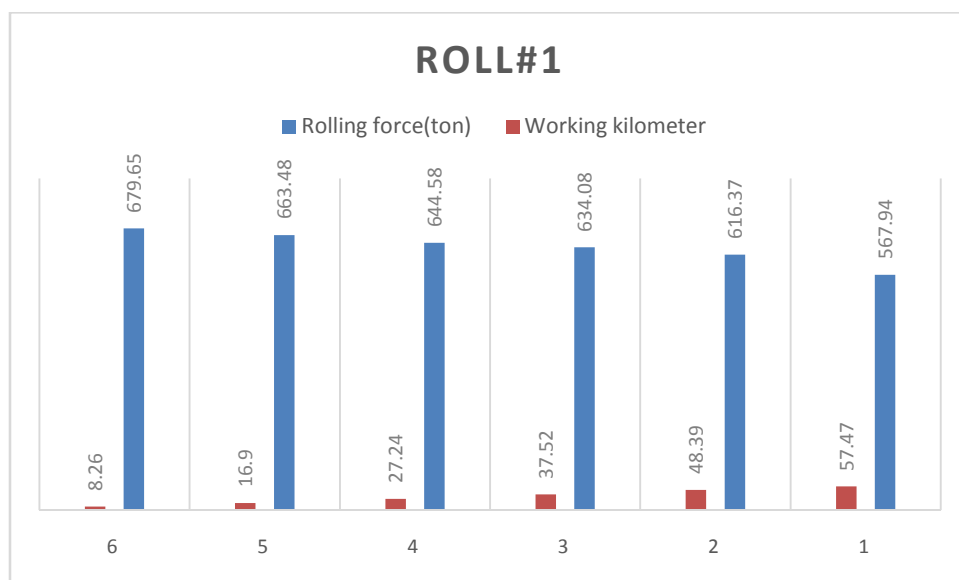

Fig.5. The variation of the rolling force versus the working kilometer of work rolls with 27 micro inches of surface roughness

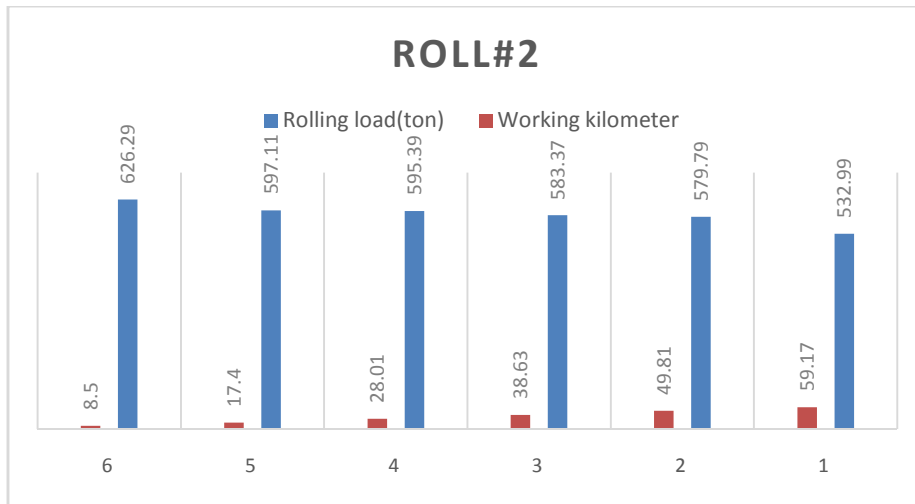

Fig.6.The variation of the rolling force versus the working kilometer of work rolls with 27 micro inches of surface roughness

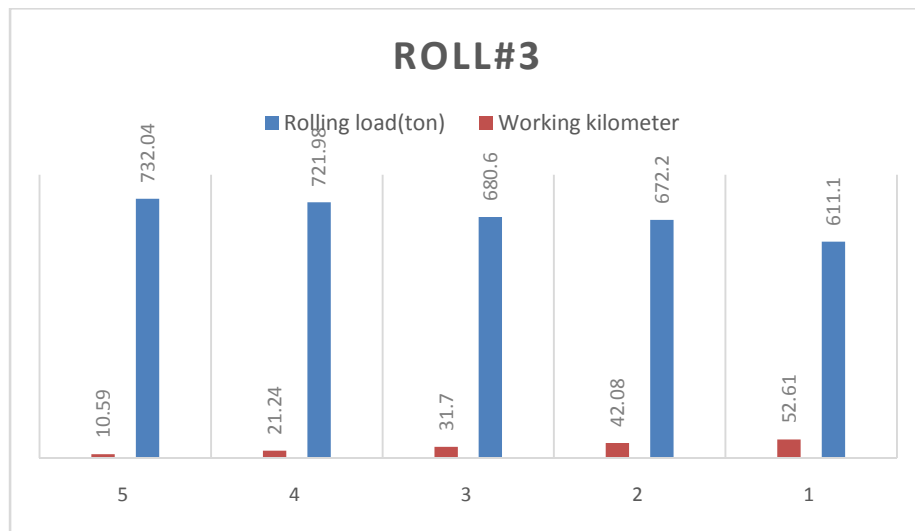

Fig.7.The variation of the rolling force versus the working kilometer of work rolls with 30 micro inches of surface roughness

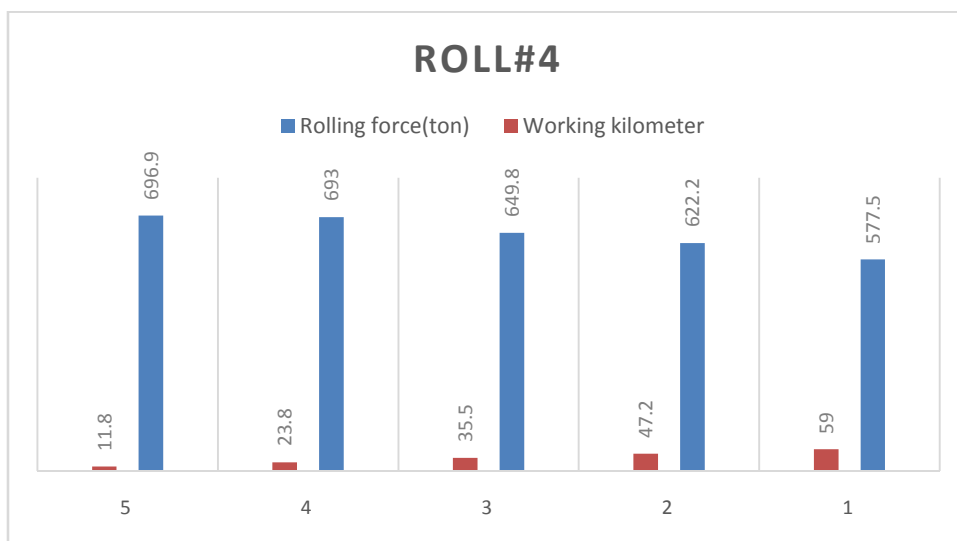

Fig.8. The variation of the rolling force versus the working kilometer of work rolls with 30 micro inches of surface roughness

3. Results and discussion

According to figures 5 to 8, increasing the surface roughness of the rolls up to 30 micro inches severely increases the rolling force. By decreasing the surface roughness of the rolls, their working kilometer decreases. After rolling different coils, the surface roughness of the rolls reached to 26 micro inches. This roughness was an appropriate amount to roll thin steel strips with a thickness less than 0.18 millimeters. In this rolling system, the appropriate amount for rolling thin steel strips is about 24-28 micro inches. So, first of all, it is better to grind the work rolls with 24-28 micro inches in the roll shop.

Based on an experimental study on two work rolls in the two stand reversing cold mill and according to figure9, a roll with 28 micro inches surface roughness rolls 120 kilometers of steel strip and a roll with 20 micro inches surface roughness rolls 80 kilometers of steel strip. According to figure9, decreasing the surface roughness of the rolls decreases their working kilometers and efficiency.

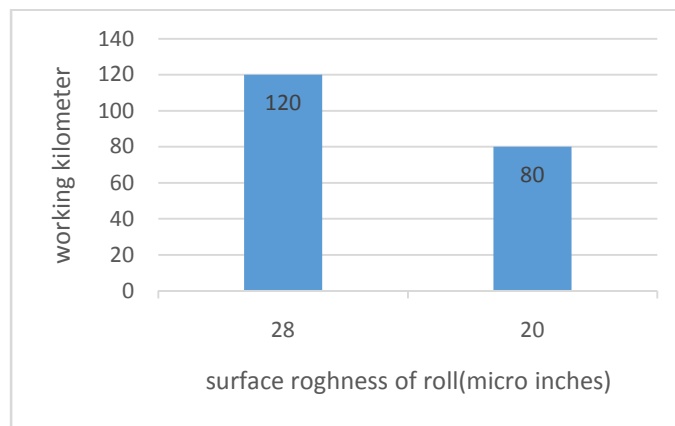

Fig.9. Effect of the surface roughness of the rolls on their working kilometers in the two stand reversing cold mill

For increasing the efficiency of the rolling system, increasing the surface roughness of the rolls is necessary. There are several popular methods to retexture the work rolls such as shot blast and electro discharge texturing (EDT). For increasing the efficiency of rolling process in the rolling system, the second part of this study involves selecting an appropriate method to retexture the work rolls. Figure10 demonstrates the texturing mechanism with a shot blast machine. The main parts of a shot blast machine include

1. Centrifugal wheel
2. Steel seeds
3. Holes deformed by plastic deformation on the surface of rolls

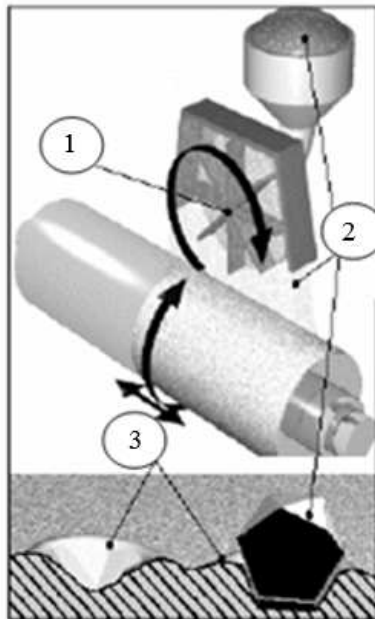

Fig.10. Roll texturing mechanism by a shot blast machine

Roll texturing mechanism in this method has been done by plastic deformation of the steel seeds. Due to the work hardening of the material on the surface of the rolls, shot blast creates a durable texture. There are two other methods to retexture the work rolls which are not applicable in comparison with the shot blast and electro discharge texturing (EDT) Such as electron beam texturing (EBM) and laser texturing (LT). Both of them create a regular texture pattern which fascinates the crack propagation on the surface of roll. So, EBM and LT are not appropriate techniques for roll texturing [5]. It is impossible to retexture a roll with surface roughness smaller than 50 micro inches by shot blast due to the size of the steel seeds. The other method for roll texturing is EDT. According to figure 11, due to the electrical potential difference between the work roll and the electrode, dielectric changes to plasma and a spark creates a hole on the surface of the roll. EDT can create a texture pattern with 0.5 micrometer.

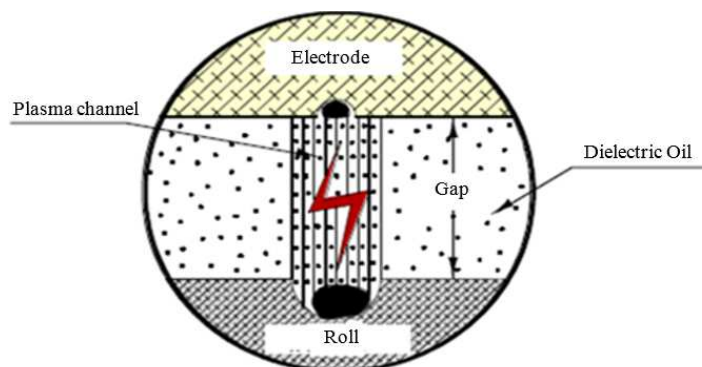

Fig. 11. Electro discharge texturing mechanism

Table 1 compares the difference between durability of textures created by EDT and shot blast.

Table 1. Durability of textures created by EDT and shot blast

Roll texturing method	Roll number	Primary texture (micro inches)	Final texture (micro inches)	Retextured coils (ton)
Shot blast	516602	120	60	1378
EDT	515599	120	60	500
Shot blast	516590	120	60	1186
EDT	515588	120	60	536

According to Table 1, for finding an appropriate texturing method, four rolls have been retextured by shot blast and EDT with 120 micro inches of surface roughness. They have been montaged in the fifth stand of the five stand tandem mill. This stand retextures steel strips before coloring step in the Mobarakeh Steel Company in Esfahan. After reaching to 60 micro inches of surface roughness, each roll has been sent to the roll shop for roll texturing. According to Table 1, both of the work rolls prepared by shot blast retextured 1378 and 1186 tons of steel strips. Also, the other two rolls prepared by EDT retextured 500 and 536 tons of steel strips. As can be seen in Table 1, the durability of the texture of the work rolls retextured by shot blast is more than those retextured by EDT. So, the shot blast method can be used as an appropriate method to retexture work rolls and to increase the efficiency of the rolling process in the two stand reversing cold mill.

4. Conclusion

1. At the beginning of the rolling process, due to the high surface roughness of the work rolls, increasing the ratio of lubrication-to-water ratio for decreasing the rolling force is recommended.
2. Primary surface roughness about 23-25 (average value) micro inches for work rolls is recommended to increase the efficiency of the rolling process in the two stand reversing cold mill.
3. Retexturing work rolls with a low surface roughness severely decreases the working kilometers of them. So, the shot blast method can be used as an appropriate method to retexture work rolls and to increase the efficiency of the cold rolling process.

5. Acknowledgment

Support of R&D of Mobarakeh Steel Company is appreciated.

6. References

- [1] Kumar, M. 2006. Analysis of Strip Rolling using FEM and Numerical Integration Techniques. IE (I) Journal-MC. 87, 3-9.
- [2] Roberts, W L. 1978. Cold Rolling of Steel. Marcel Dekker Inc. New York and Basel.
- [3] Lee, YH. , Chun, WI. Roh. 2000. Two-stand temper and double reduction mill at Dongbu Steel Asan Bay Works. Metall. Res. Technol. 97, 1391-1398.
- [4] Moshksari, M. 2005. Fundamentals of rolling. 2nd ed. Shiraz University. 2005. Chaps. 5, 6, 8.
- [5] EB, Li. 2003. Application of digital image correlation technique to dynamic measurement of the velocity field in the deformation zone in cold rolling. Optics and lasers in engineering. 39, 479-488.
- [6] František, Ďurovský. Ladislav, Zboray. , Želmíra, Ferková. 2008. Computation of Rolling Stand Parameters by Genetic Algorithm. Acta Polytechnica Hungarica. 5(2), 59-70.

- [7] Heydarivini, M., Ebrahimi, H., Ziaeimoghadam, H.R. and Jafarian, M. 2012. A new approach to determine the friction hill curves, rolling load and analysis of permanent failure of work rolls in an actual cold rolling. International Conference on Materials Heat Treatment. May 30-31. Isfahan. Iran.

