

# Experimental Investigation of Thermal Conductivity of Aluminum Alloy 3003 Produced by Equal Channel Angular Rolling Process

Mohammad Honarpoosh<sup>1\*</sup>, Mohammad Reza Aghili<sup>2</sup>, Mahdi Kotobi<sup>3</sup>

<sup>1</sup>Faculty of Mechanical Engineering, University of Kashan, Kashan, Iran.

\*Email of corresponding author: honarpoosh@kashanu.ac.ir

<sup>2</sup>Faculty of Engineering, Jash branch, Islamic Azad University.

<sup>3</sup>Faculty of Mechanical Engineering, University of Kashan, Kashan, Iran.

*Received: November 23, 2015; Accepted: December 30, 2015*

## Abstract

Equal channel angular rolling (ECAR) process is one of the methods that have been used to make ultra-fine materials by imposing severe plastic deformation. After repeating the process several times, a large effective strain is applied to the sample that can cause decreasing the grain size and improving the mechanical and physical properties of the metal. In this study, thermal conductivity of the samples that were produced by ECAR was investigated experimentally. Accordingly, the strips of aluminum alloy 3003 were ECARed up to 10 passes through route-A and route-C. The effect of number of ECAR pass and routes of ECAR process (A and C) were investigated. Furthermore, tensile behavior and micro-hardness of ECARed samples were studied. According to the results, the thermal conductivity of samples increased up to definite pass and raised to its maximum value, then had an oscillatory trend up to tenth pass. Although this improvement of the thermal conductivity wasn't significantly, but the improvement of yield and ultimate strength and micro-hardness of the samples in passes associated with the maximum thermal conductivity, were meaningful and so, this ECARed alloys can be used in harder situation.

## Keywords

Severe plastic deformation, Equal channel angular rolling, Thermal conductivity, Aluminum alloy 3003

## 1. Introduction

Severe plastic deformation (SPD) methods are metal forming process that have been used to produce ultra-fine grain (UFG) materials by imposing extreme-large plastic strains into the material. Different Severe plastic deformation processes have been developed for parts with various shapes. To create UFG and Nano-structured materials in bulk specimens, SPD process like equal channel angular pressing (ECAP), high pressure torsion (HPT) and cyclic extrusion compression (CEC) have been extended. Process like constrained groove pressing (CGP) and accumulative roll bonding (ARB) have been used for sheet samples [1-2].

Equal channel angular rolling (ECAR) process is one of the SPD methods that have been used to create UFG materials in sheet form specimens. A Schematic of the ECAR device is shown in Fig. 1. It consists of two rolls and two channels. Mostly, the thickness of outlet channel is similar to the sample thickness, but the thickness of inlet channel is less than thickness of outlet channel and the gap between the rolls is set to the thickness of inlet channel to feed the sample into the device by friction force. Severe plastic deformation is created on the sample at zone where the inlet and outlet channels intersect. In the ECAR process, two routes can be used. If the sample is fed to the rolls in a same direction in each sequential pass, known as route A. In route C, the sample is rotated around

the longitudinal axis by  $180^\circ$  in the same direction after each sequential pass as it shown in Fig. 2 [3].

Applying ECAR process on the Al alloys such as 1050, 7050, 6063 and 1100-O, caused structural improvement, creating ultra-fine structure, yield and ultimate strength increase and micro-hardness growth. Although this process decreased the elongation of these samples [4-8].

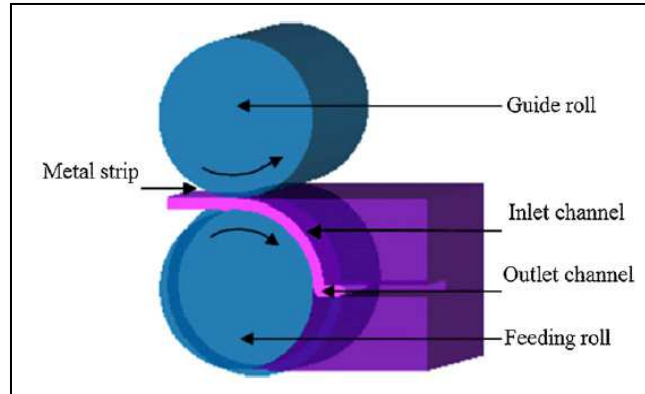

Fig.1. A schematic of the ECAR device [3]

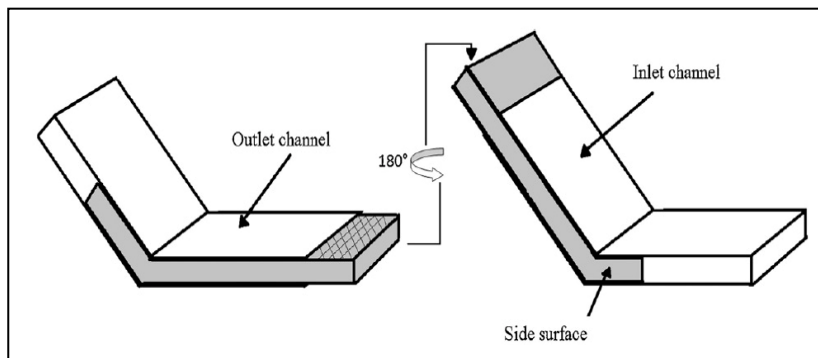

Fig.2. A schematic of route C in ECAR process [3]

Cheng et al. [9-10] showed that using ECAR process can improve drawability of AZ31 magnesium alloy sheet at room temperature. In another study, Cheng et al. [11] investigated the effect of channel clearance on ECAR process and concluded that shear angle was decreased by increasing of channel clearance. Hassani and ketabchi investigated AZ31 alloy ECAR process and reported that elongation of the 10-passes ECARed specimen was improved and average grain size was decreased meaningfully from  $21\mu\text{m}$  in initial sample to about 14-70 nm after 10 passes. Also, ECAR process increased micro-hardness of the material [12]. Habibi et al. [3] investigated pure copper ECAR process. According to their work, this process increased strength and micro-hardness of the sample besides creating Nano-structure in the material. Applying ECAR process decreased the elongation of the samples. Habibi and Ketabchi [13] examined the effect of annealing after ECAR process and concluded that post-annealing improved the elongation and electrical conductivity of ECARed copper samples. Kvačĥaj et al. [14] investigated the OFHC copper was subjected to ECAR process and deduced that ECAR process caused decreasing the grain size and increasing strength and micro-hardness of the samples. Park et al. [15] studied the effect of ECAR process on the low carbon steel plate. The ECAR process caused about 100% improvement in the yield stress and also noteworthy raise in the ultimate tensile strength and micro-hardness of the sample.

Different Heat transfer process can be quantified by suitable rate equation. Fourier’s law is the rate equation that be used inthe heat conduction. It can be expressed asequation (1) for one-dimensional heat transfer in a part with temperature distribution T(x).

$$q = -kA \frac{dT}{dx} \tag{1}$$

Where k is one of the material properties that known as thermal conductivity (W/m. K). In fact, this property of the material shows its ability to conductionheat transfer. The magnitude of thermal conductivity is in a wide range for different materials such as metals, liquids, gases and so on. Fig. 3 shows the magnitude variation of thermal conductivity in different group of materials [16-18].

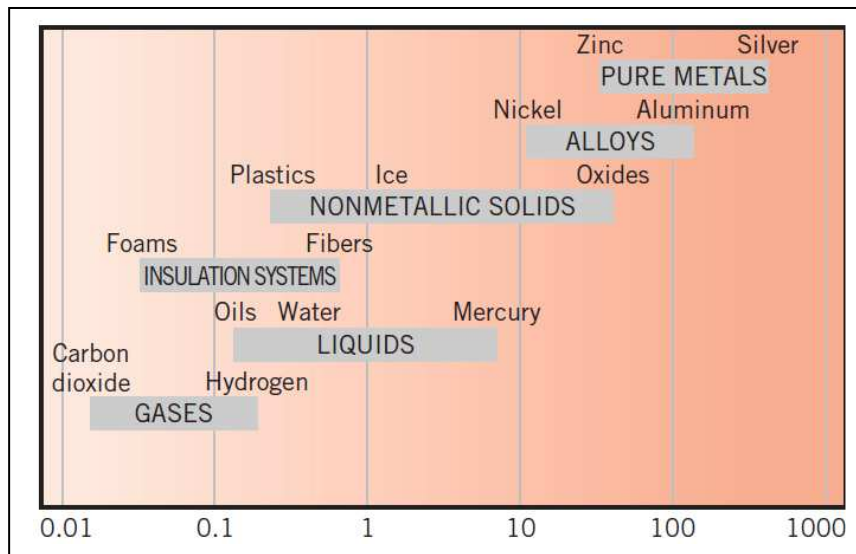

Fig.3. Thermal conductivity of different materials [16]

Although various investigations on materials were fabricated by ECAR process have been performed in recent years, but the study of thermal conductivity of ECARed samples are not still investigated until now (as far as the authors know). As the thermal conductivity is one of the important properties in industry, in this study the variation of thermal conductivity of Aluminum Alloy 3003 ECARed samples were investigated experimentally. Accordingly, strips of aluminum alloy 3003 were ECARed up to 10 passes through route-A and route-C. After sample preparation, heat conduction test was performed and thermal conductivity of samples was calculated. The effect of number of ECAR pass and routes of ECAR process (A and C) were investigated. Furthermore, mechanical properties of some samples (micro-hardness, yield and ultimate tensile strength) were studied.

## 2. Experimental work

### 2.1. ECAR process

In this study, aluminum alloy 3003 that have been utilized in the heating and cooling industries was used as the test material. Strips with dimensions of 400×40×3 mm<sup>3</sup> (length × width × thickness) were prepared. The ECAR device that was used in this study is shown in Fig. 4. Rotational motion of the rollers have been supplied by an engine with a power of 1.5 kW. The ECAR die has a 120° corner angle. The thickness of inlet and outlet channels are 2.9 and 3 mm, respectively. SAE 11 was

used to lubricate the die surface. The strips of aluminum alloy 3003 were ECARed up to 10 passes through route-A and route-C at the room temperature. Fig. 5 shows some of ECARed samples.

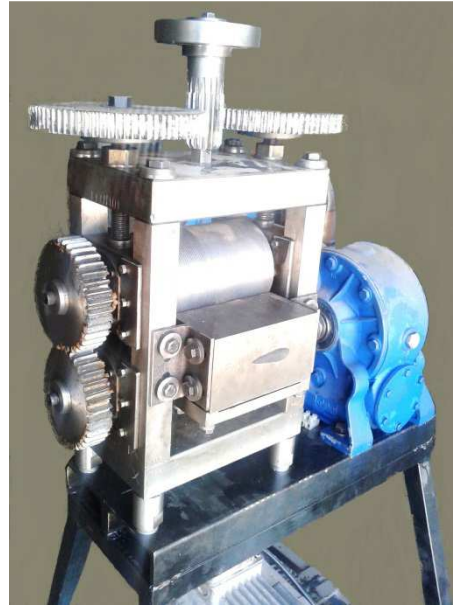

Fig.4. ECAR device



Fig.5. ECARed samples

Tensile test samples were prepared along the ECAR direction using wire cut. The dimensions of the samples were  $100 \times 10 \times 4 \text{ mm}^3$  based on the ASTM standard E8M [19]. Uniaxial tensile tests were performed at the room temperature. Micro-hardness of some samples was measured by Vickers hardness tester with pyramidal diamond indenter subject 300g load for 10s (HV0.3) [20].

## 2.2. Heat conduction test

Samples of Heat conduction test were prepared by blanking operation. Samples with 25 mm in diameter were cut from the middle of the ECARed strips, because in this region the sheet was flat and without distortion. The samples were polished to have a completely flat surface for heat conduction test.

Heat conduction apparatus and the schematic of it are shown in Figs. 6-7, respectively. To measure the thermal conductivity of the material, a thin sample of it, was set between two metals with known thermal conductivity. One of the metals was connected to a heat source and the other was connected to the cooler as shown in Fig.5. It should be noted that to have an ideal connect the samples must be

polished. Also, to reduce thermal resistance between the sample and the metals, heat sink compound was used. To prevent heat loss by radiation or convection, a special coating was applied. Fig. 8 shows the location of placing the sample in the apparatus and the prepared sample. Six sensors were used to measure temperature in the different locations. These sensors are shown in Fig. 9.



Fig.6. Heat conduction apparatus

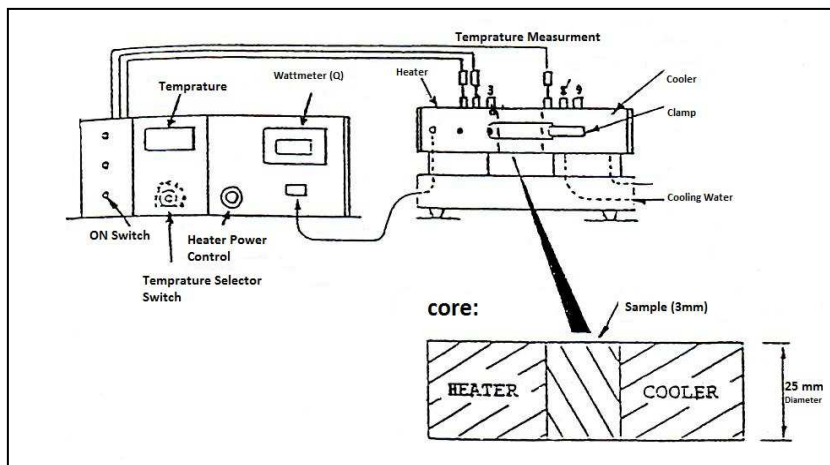

Fig.7. A schematic of Heat conduction apparatus

It must be noted that because the temperature variations across the cylinders was low in this test, temperature gradient can be considered constant. So, the slope of each segment was assumed to be equal.

Before recording the results of the test, heat flow should be reached to a stable and uniform condition. In other words, the results of the test were recorded when the temperature between different parts of the cylinders remained constant or changed slowly.

After recording the temperature, thermal conductivity of the sample ( $k$ ) can be calculated by Fourier's law:

$$q = -kA \frac{\Delta T}{\Delta x} \quad (2)$$

$$k = \left(\frac{q}{A}\right) \left(\frac{\Delta x}{\Delta T}\right) \quad (3)$$

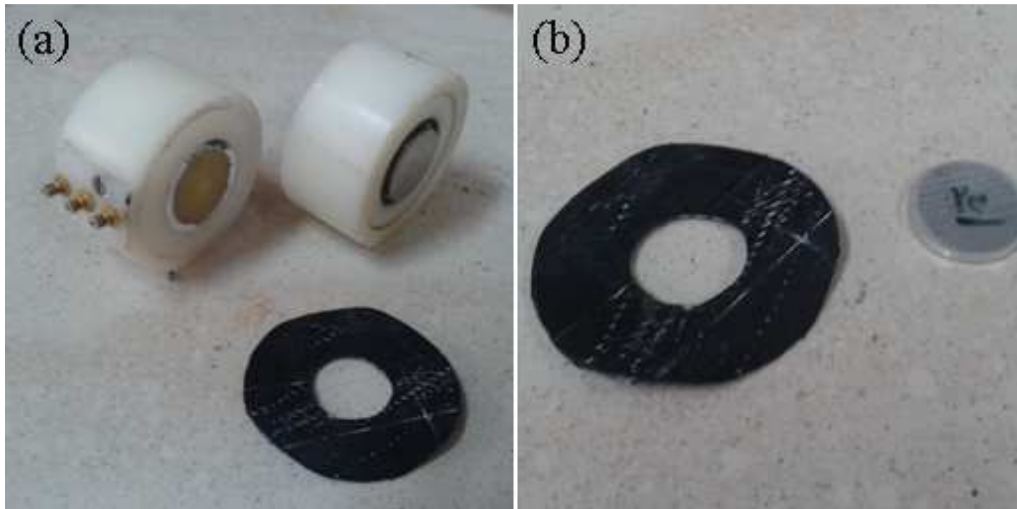

Fig.8. (a) The insulating Teflon coating and brass cylinders, (b) The prepared sample



Fig.9. The temperature sensors

### 3. Result and Discussion

#### 3.1. The effect of number of ECAR passes

Fig. 10 shows the variation of thermal conductivity of route-A samples. The amount of thermal conductivity was increased from 187.16(w/m.°K) in the control sample to 189.41(w/m.°K) after the first pass. This trend continued up to fourth pass and in this pass had the magnitude of 193.49(w/m.°K). In fifth pass the value of  $k_{was}$  decreased to 186.74(w/m.°K). This trend continued through the seventh pass and reached to its lowest value 180.33(w/m.°K). Then the value of  $k_{was}$  increased until tenth pass to 185.37(w/m.°K). The variation of thermal conductivity of route-C samples is shown in Fig. 10. The first pass of the ECAR process in both routes A and C is identical. In this case the maximum value of  $k_{was}$  obtained in the fourth pass that had the magnitude of 191.81(w/m.°K). Then, the thermal conductivity was decreased to seventh pass like route-A. After that  $k_{was}$  increased to ninth pass and finally was reduced to 184.09 (w/m.°K) in the tenth pass. The reduction of thermal conductivity from the fifth pass to seventh pass in both route-A and route-C can be attributed to strain hardening and increase of dislocation density that happened in the sample during first passes of ECAR process. Because these dislocations can behave as thermal resistance and reduce thermal conductivity.

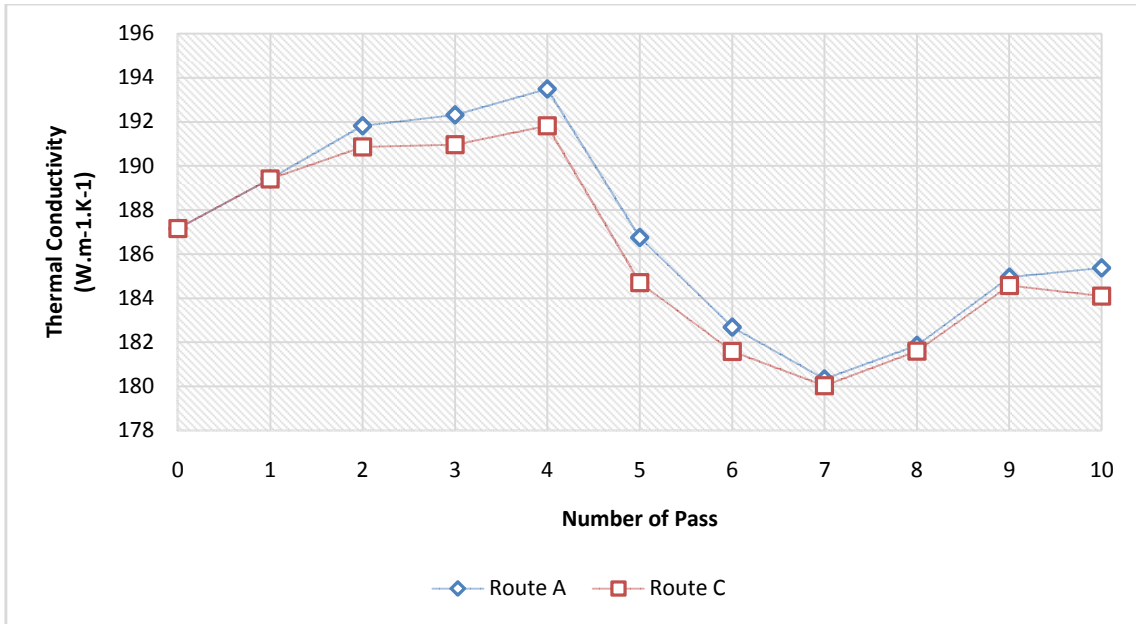

Fig.10. Thermal conductivity of route-A and route-C samples

### 3.2. The effect of ECAR process route

As shown in Fig. 10, in both route-A and route-C the magnitude of thermal conductivity of samples was increased from first pass to fourth pass, then had a downtrend to seventh pass. The value of  $k$  was maximum in the fourth pass and was minimum in the seventh pass in both routes. On the fifth pass, the magnitude of  $k$  was less than of that for the control sample. As it can be seen in Fig. 10, the magnitude of  $k$  in route-A was a little greater than route-C.

### 3.3. Mechanical properties

The variation of yield and ultimate tensile strength and micro-hardness of the samples in passes associated with the maximum thermal conductivity are shown in Fig. 11. As it can be seen in this Fig, the magnitude of yield and ultimate tensile strength and micro-hardness of the samples were improved significantly in both routes in compare with the control sample.

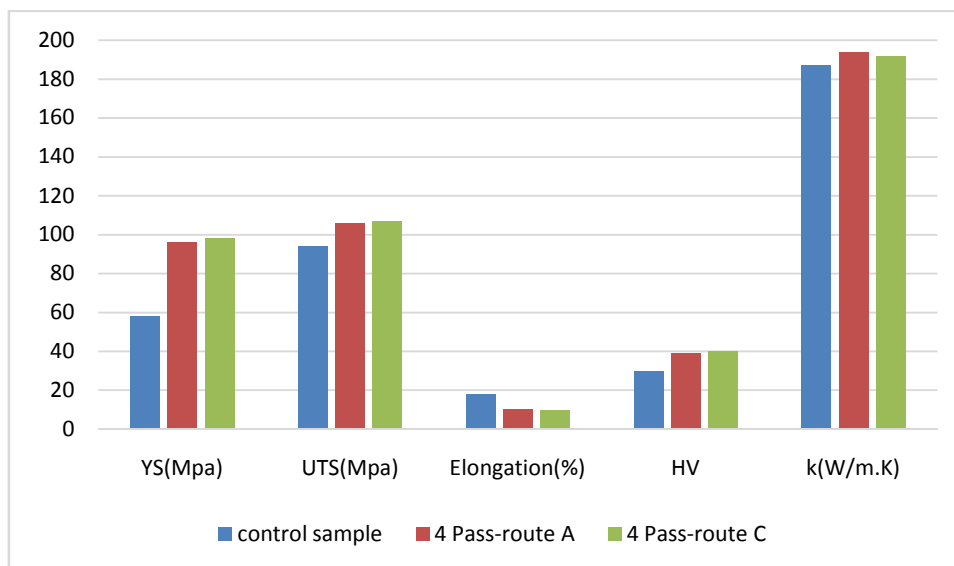

Fig.11. Properties of the sample before ECAR and after 4 passes

#### 4. Conclusion

Ultra-fine materials (UFG) have appropriate combination of different mechanical and physical properties. Consequently, extensive research on UFG materials and methods used to produce these materials, have been performed. ECAR process is one of the severe plastic deformation methods that have been used in sheet form samples to improve material structure and physical and mechanical properties of the materials. In this study the effect of ECAR process on the thermal conductivity of a material was investigated for the first time. Hence, the strips of aluminum alloy 3003 were ECARed up to 10 passes through route-A and route-C. Then, heat conduction test was performed and thermal conductivity of prepared samples was calculated. Besides, micro-hardness and tensile behavior of some samples were investigated. The following results can be reported:

- 1- According to the results, with increasing number of ECAR pass, thermal conductivity had an uptrend and was raised to its maximum value, then had an oscillatory trend, as in route-A samples  $k$  was increased up to fourth pass, decreased from fifth to seventh pass, and then was increased somewhat from the eighth to the tenth pass.
- 2- Comparison of  $k$  in both route-A and route-C showed that the variation trend of  $k$  versus number of pass was identical in both routes. Although the magnitudes of  $k$  in route-A were somewhat greater than route-C.
- 3- Although improvement of the thermal conductivity of AA 3003 samples was not significantly, but the improvement of yield and ultimate strength and micro-hardness of the samples in passes associated with maximum thermal conductivity, were meaningful. So, this ECARed alloys can be used in harder situation and more applications.

#### 5. References

- [1] Azushima, A., Kopp, R., Korhonen, A., Yang, D.Y., Micari, F., Lahoti, G.D., Groche, P., Yanagimoto, J., Tsuji, N., Rosochowski, A. and Yanagida, A. 2008. Severe plastic deformation (SPD) processes for metals, *CIRP Annals - Manufacturing Technology*, 57(2), 716–735.
- [2] Khodabakhshi, F., Abbaszadeh, M., Eskandari, H. and Mohebpour, S.R. 2013. Application of CGP-cross route process for microstructure refinement and mechanical properties improvement in steel sheets, *Journal of Manufacturing Processes*, 15(4), 533-541.
- [3] Habibi, A., Ketabchi, M. and Eskandarzadeh, M. 2011. Nano-grained pure copper with high-strength and high-conductivity produced by equal channel angular rolling process, *Journal of Materials Processing Technology*, 211(6), 1085–1090.
- [4] Lee, J. C., Seok, H.K. and Suh, J.Y. 2002. Microstructural evolutions of the Al strip prepared by cold rolling and continuous equal channel angular pressing, *Acta Materialia*, 50(16), 4005–4019.
- [5] Lee, J.C., Seok, H.K., Suh, J.Y., Han, J.H. and Chung, Y.H. 2002. Structural Evolution of a Strip-Cast Al Alloy Sheet Processed by Continuous Equal-Channel Angular Pressing, *metallurgical and Materials Transactions A*, 33(3), 665-673.
- [6] Nam, C.Y., Han, J.H., Chung, Y.H. and Shin, M.C. 2003. Effect of precipitates on microstructural evolution of 7050 Al alloy sheet during equal channel angular rolling, *Materials Science and Engineering: A*, 347(1), 253–257.
- [7] Chung, Y.H., Park, J.W. and Lee, K.H. 2006. An Analysis of Accumulated Deformation in the Equal Channel Angular Rolling (ECAR) Process, *Metals and Materials International*, 12(4), 289–292.



- [8] Azimi, A., Tutunchilar, S., Faraji, G. and BesharatiGivi, M.K. 2012. Mechanical properties and microstructural evolution during multi-pass ECAR of Al 1100–O alloy, *Materials and Design*, 42, 388–394.
- [9] Cheng, Y.Q., Chen, Z.H. and Xia, W.J. 2007. Drawability of AZ31 magnesium alloy sheet produced by equal channel angular rolling at room temperature, *Materials Characterization*, 58(7), 617–622.
- [10] Cheng, Y.Q., Chen, Z.H., Xia, W.J. and Zhou, T. 2008. Improvement of Drawability at Room Temperature in AZ31 Magnesium Alloy Sheets Processed by Equal Channel Angular Rolling, *Journal of Materials Engineering and Performance*, 17(1), 15-19.
- [11] Cheng, Y.Q., Chen, Z.H., Xia, W.J. and Zhou, T. 2007. Effect of channel clearance on crystal orientation development in AZ31 magnesium alloy sheet produced by equal channel angular rolling, *Journal of Materials Processing Technology*, 184(1), 97–101.
- [12] Hassani, F.Z. and Ketabchi, M. 2011. Nano grained AZ31 alloy achieved by equal channel angular rolling process, *Materials Science and Engineering: A*, 528(21), 6426– 6431.
- [13] Habibi, A. and Ketabchi, M. 2012. Enhanced properties of nano-grained pure copper by equal channel angular rolling and post-annealing, *Materials and Design*, 34, 483–487.
- [14] Kvačkaj, T., Kováčová, A., Kvačkaj, M., Kočiško, R., Lityńska-Dobrzyńska, L., Stoyka, V. and Miháliková, M. 2012. TEM Studies of Structure in OFHC Copper Processed by Equal Channel Angular Rolling, *Micron*, 43(6), 720–724.
- [15] Park, J.W., Kim, J.W. and Chung, Y.H. 2004. Grain refinement of steel plate by continuous equal-channel angular process, *ScriptaMaterialia*, 51(2), 181–184.
- [16] Bergman T.L., Lavine A.S., Incropera F.P. and Dewitt D.P. 2011. *Fundamentals of Heat and Mass Transfer*, seventh edition, John Wiley & Sons.
- [17] Jiji, L.M. 2009. *Heat Conduction*, Third Edition, Springer.
- [18] Hahn, D.W. and Ozisik, M.N. 2012. *Heat conduction*, Third Edition, John Wiley & Sons.
- [19] ASTM E8M-09. Standard test methods for tension testing of metallic materials, Pennsylvania (United States): ASTM International; (December 2009).

