

Intelligent Knowledge Based System Approach for Optimization of Design and Manufacturing Process for Wire-Electrical Discharge Machining

Morteza Sadegh Amalnik^{1*}

¹Mechanical and Manufacturing Engineering Department University of Qom, Qom, Islamic Republic of Iran

*Email of Corresponding Author: sadeghamalnik@yahoo.com

Received: April 17, 2015; Accepted: June 27, 2015

Abstract

Wire electrical discharge machining (WEDM) is a method to cut conductive materials with a thin electrode that follows a programmed path. The electrode is a thin wire. Typical diameters range from .004" - .012" (.10mm - .30mm) although smaller and larger diameters are available. WEDM is a thermal machining process capable of accurately machining parts with varying hardness or complex shapes. WEDM process is based on electrical discharge machining (EDM) sparking phenomenon, utilizing the widely accepted non-contact technique of material removal. The hardness of the work piece material has no detrimental effect on the cutting speed. There is no physical contact between the wire and the part being machined. Rather, the wire is charged to a voltage very rapidly. This wire is surrounded by deionized water. When the voltage reaches the correct level, a spark jumps the gap and melts a small portion of the work piece. The deionized water cools and flushes away the small particles from the gap. This paper addresses the concept of WEDM and its parameters and development of an intelligent knowledge based system (IKBS) for WEDM in computer based concurrent engineering environment. The system links with a feature based CAD system in order to extract design data. The system is linked with databases. The machining cycle time, cost, material removal rate, and surface roughness of hole making are estimated for each selected design feature. The system provides useful information for product designers and manufacturing engineers and also advises manufacturing engineers to select optimum machining parameters.

Keywords

Knowledge based system, wire electrical discharge machining, Optimization

1. Introduction

Wire-electrical discharge machining (WEDM) is an important non-traditional machining process, widely used in the aerospace and automotive industry [1]. The material removal mechanism of WEDM is very similar to the conventional EDM. WEDM was first introduced in the late 1960s. The development of the process was the result of seeking a technique to replace the machined electrode used in EDM. In 1974, D. H. Dulebohn applied the optical-line follower system to automatically control the shape of the component to be machined by the WEDM process [2]. The CNC machine can independently move four machines axes to generate taper cuts. A stamping die can be machined with 1/4 degree taper or a mold with one degree taper in some areas and two degrees in another with precision. Extrusion dies can be cut with the taper constantly changing. For example, a detailed shape on the top of the work piece can transition to a simple circle on the bottom. WEDM can be accurate to +/-0.0001". Virtually no burrs are generated. Since no cutting forces are present, WEDM is ideal for delicate parts. No tooling is required so delivery times are

short. Pieces up to 16" thick can be machined. Tools and parts are machined after heat treatment, so dimensional accuracy is held and not affected by heat treat distortion. WEDM is a machine that is more accurate, precise and less costly to operate. The Wire EDM ranges features rigid linear motors; rigid linear motors maximize cutting performance and give the part accuracy that is needed to be the any of the competition. The WEDM process has the ability to machine precise, complex and irregular shapes. Furthermore, the high degree of accuracy and the fine surface finish make WEDM valuable. Recently, WEDM is being used to machine a wide variety of parts from metals, alloys, sintered materials, cemented carbides, ceramics and silicon [3- 6]. The selection of cutting parameters for obtaining higher cutting efficiency or accuracy in WEDM is still not fully solved, even with the most up-to-date CNC WEDM machine. This is mainly due to the nature of the complicated stochastic process mechanisms in WEDM [7-10]. As a result, the relationships between the cutting parameters and the process performance are hard to model accurately. In addition, the WEDM process is able to machine exotic and complex part. WEDM is a unique adaptation of the EDM process, which is a continuously travelling wire electrode made of thin copper, brass or tungsten of diameter 0.05–0.3 mm. The wire is kept in tension, using a mechanical tensioning device, reducing the tendency of producing inaccurate parts. In WEDM process, the material is eroded ahead of the wire and there is no direct contact between wire and the work piece. In WEDM, material is eroded from the work piece by a series of discrete sparks occurring between the wire and the work piece separated by a stream of dielectric fluid [11, 12]. The WEDM process makes use of electrical energy, generating a channel of plasma between the cathode and anode[13], and turns it into thermal energy [14] at a temperature as high as 20,000 C [15] initializing a substantial amount of heating and melting of work piece material on the surface of each pole. Thin wire is used continuously feeding through the work piece by a microprocessor, which enables parts of complex shapes to be machined with high accuracy. The wire has to make several machining passes along the profile to be machined to attain the required dimensional accuracy and surface finish (SF) quality. When the pulsating direct current power supply occurring between 20,000 and 30,000 Hz [16] is turned off, the plasma channel breaks down. This causes a sudden reduction in the temperature, allowing the circulating dielectric fluid to implore the plasma channel and flush the molten particles from the pole surfaces in the form of microscopic debris. A varying degree of taper ranging from 15 for a 100 mm thick to 30 for a 400 mm thick work piece can also be obtained on the cut surface. The microprocessor also constantly maintains the gap between the wire and the work piece, which varies from 0.025 to 0.05 mm [17]. Feasibility of conducting dry WEDM is tested to improve the accuracy of the finishing operations, which were conducted in a gas atmosphere without using dielectric fluid [18]. The typical WEDM cutting rates (CRs) are 300 mm²/min for a 50 mm thick D2 tool steel and 750 mm²/min for a 150 mm thick aluminum [11], and SF quality is as fine as 0.04–0.25 μRa. In addition, WEDM uses deionised water instead of hydrocarbon oil as the dielectric fluid and contains it within the sparking zone. The deionised water is not suitable for conventional EDM as it causes rapid electrode wear, but its low viscosity and rapid cooling rate make it ideal for WEDM [19]. Various researches in WEDM can be divided into two major areas namely WEDM process optimization together with WEDM process monitoring and control. Different factors are affecting the WEDM process and seeking the different ways of obtaining the optimal machining condition and performance. Ultrasonic vibration is used to apply to the wire electrode to improve the SF quality together with the CR and to reduce the residual stress

on the machined surface [20]. A rotary axis is also added to WEDM to achieve higher material removal rate (MRR) and to enable the generation of free-form cylindrical geometries [21]. The effects of the various process parameters such as part rotational speed, wire feed rate and pulse on-time on the surface integrity and roundness of the produced part have been investigated in the same feasibility study [22].

2. WEDM operation and parameters

Wire electrical discharge machining (Wire-EDM) is a non-traditional material removal process used to manufacture components with intricate shapes and profiles. It is considered as a unique adaptation of the conventional EDM process, which uses an electrode to initialize the sparking process. However, Wire-EDM utilizes a continuously travelling wire electrode made of thin copper, brass or tungsten of diameter 0.05–0.3 mm, which is capable of achieving very small corner radii. The wire is kept in tension, using a mechanical tensioning device, reducing the tendency of producing inaccurate parts. During the Wire-EDM process, the material is eroded ahead of the wire and there is no direct contact between the work piece and the wire, eliminating the mechanical stresses during machining. In addition, the Wire-EDM process is able to machine exotic and high strength and temperature resistive (HSTR) materials and eliminate the geometrical changes occurring in the machining of heat-treated steels. Wire-EDM was first introduced to the manufacturing industry in the late 1960s. The development of the process was the result of seeking a technique to replace the machined electrode used in EDM. In 1974, the optical-line follower system automatically controls the shape of the component to be machined by the Wire-EDM process. After that popularity had rapidly increased, the process and its capabilities were better understood by the industry. Figure 1 shows diagram of WEDM, Figure 2 shows diagram of process in WEDM and Figure 3 shows schematic diagram of discharge machining between wire and work piece in WEDM.

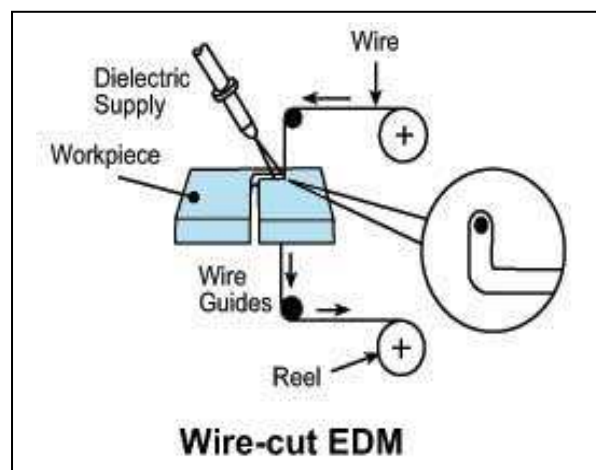

Figure 1. Schematic diagram of WEDM

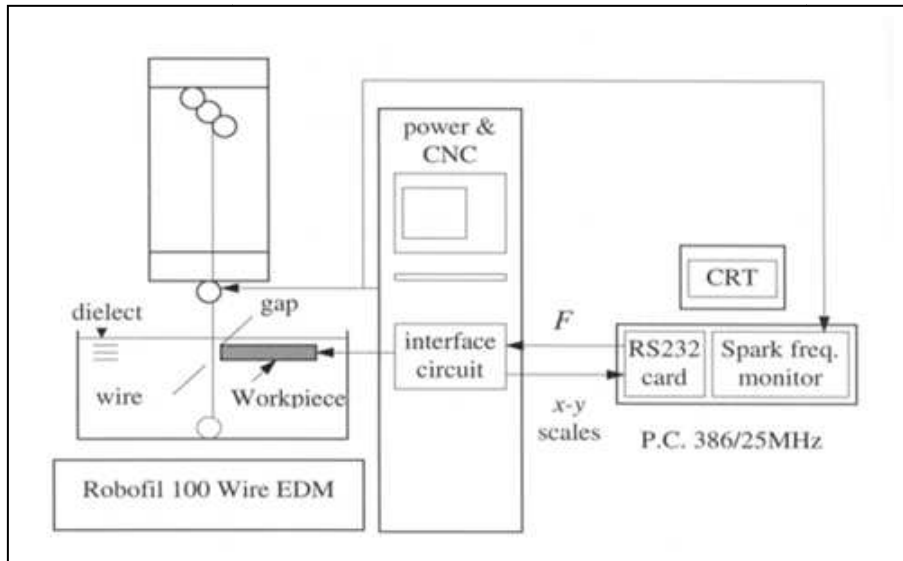

Figure2. Schematic diagram of process in WEDM

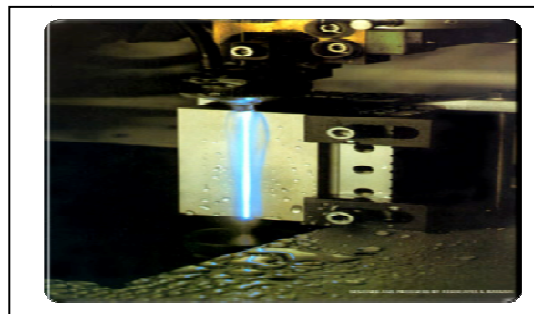

Figure3. Schematic diagram of discharge machining between wire and work piece

3. Parameters effect on WEDM

3.1 Effects of the process parameters on the cutting rate

Many different types of problem-solving quality tools have been used to investigate the significant factors and its inter-relationships with the other variables in obtaining an optimal WEDM CR. Konda et al. [23] classified the various potential factors affecting the WEDM performance measures into five major categories namely the different properties of the work piece material and dielectric fluid, machine characteristics, adjustable machining parameters, and component geometry. Tarn et al. [24] employed a neural network system with the application of a simulated annealing algorithm for solving the multi-response optimization problem. It was found that the machining parameters such as the pulse on/off duration, peak current, open circuit voltage, servo reference voltage, electrical capacitance and table speed are the critical parameters for the estimation of the CR and SF. Huang et al. [25] argued that several published works [26, 27] are concerned mostly with the optimization of parameters for the roughing cutting operations and proposed a practical strategy of process planning from roughing to finishing operations. The experimental results showed that the pulse on-time and the distance between the wire periphery and the work piece surface affect the CR and SF significantly. The effects of the discharge energy on the CR and SF of a MMC have also been investigated [28]. Table 1 shows parameters used in WEDM machining.

3.2 Effects of the machining parameters on the material removal rate

The effects of the machining parameters on the volumetric MRR have also been considered as a measure of the machining performance. Scott et al. [26] used a factorial design, requiring a number of experiments to determine the most favorable combination of the WEDM parameter. They found that the discharge current, pulse duration and pulse frequency are the significant control factors affecting the MRR and SF, while the wire speed, wire tension and dielectric flow rate have the least effect. Huang and Liao [29] presented the use of Grey relational and S/N ratio analysis, which also displayed similar results demonstrating the influence of table feed and pulse on-time on the MRR. An experimental study to determine the MRR and SF for varying machining parameters has also been conducted [30]. The results have been used with a thermal model to analyze the wire breakage phenomena. Table 2 shows effect of process parameters on wire tool in WEDM. The main factors contributing to the geometrical inaccuracy of the WEDM part are the various process forces acting on the wire, causing it to depart for the programmed path. These forces include the mechanical forces produced by the pressure from the gas bubbles, formed by the plasma of the erosion mechanism. Axial forces are applied to straighten the wire, the hydraulic forces are induced by the flushing, the electro-static forces are acting on the wire and the electro-dynamic forces inherent to the spark generation. As a result, the static deflection in the form of a lag effect of the wire is critically studied in order to produce an accurate cutting tool path. Table 2 shows effect of process parameters in WEDM.

Table 2. Effect of process parameters in WEDM

WEDM	WEDM performance depends on	Work piece material, dielectric fluid, Part geometry, machine characteristic, machine adjustable parameters
	Property of conductive work piece Material	Material removal rate
	Dielectric	Deionised water
	Wire tool	Wire diameter 0.025-0.05 mm
	Wire material type	Conductive material (Brass, copper, tungsten etc.)
	Wire tool performance Effect on	Material removal rate (MRR), accuracy and surface roughness
	Wire vibration	Effect on static deflection and geometry accuracy
	Material removal rate (MRR) depends on	Work piece material, Dielectric fluid, Machine characteristic, Adjustment of machine parameters, Component geometry
	Cutting frequency	20000- 30000 Hz
	Taper	15 degree for 100mm, 30 degree for 400mm
	Surface roughness	0.04- 0.25 μm R_a
	Surface roughness depends on	Discharge current intensity, Pulse frequency, Pulse duration
	Machine (process) control following factors	Pulse duration, discharge frequency, Discharge current density, cutting rate

3.3 Effects of the process parameters on the surface finish

There are also a number of published works that solely study the effects of the machining parameters on the WEDMed surface. Gökler and Ozanözgü [31] studied the selection of the most suitable cutting and offset parameter combination to get a desired surface roughness for a constant wire speed and dielectric flushing pressure. Tosun et al. [32] investigated the effect of the pulse

duration, open circuit voltage, wire speed and dielectric flushing pressure on the WEDMed work piece surface roughness. It was found that the increasing pulse duration, open circuit voltage and wire speed increase with the surface roughness, whereas the increasing dielectric fluid pressure decreases the surface roughness. Anand [33] used a fractional factorial experiment with an orthogonal array layout to obtain the most desirable process specification for improving the WEDM dimensional accuracy and surface roughness. Spedding and Wang [34] optimized the process parameter settings by using artificial neural network modeling to characterize the WEDMed work piece surfaces, while Williams and Rajurkar [35] presented the results of the current investigations into the characteristics of WEDM generated surfaces. Table 3 shows effect of process parameters on surface roughness and accuracy in WEDM.

Table 3. Effect of process parameters on surface roughness and accuracy in EDM

WEDM	Fine surface roughness	0.04–0.25 $\mu\text{m Ra}$.
	Temperature of spark energy	12000 - 20000 centigrade
	Pulse frequency direct current	20000-30000 Hz
	Increase wire tension	Increase surface roughness
	Increase pick current	Increase surface roughness
	Slow Cutting rate	Improve surface roughness and dimensional accuracy
	Increase wire tension	Increase surface roughness
	Fine Surface roughness	0.04- 0.25 $\mu\text{m R}_a$
	Increase material removal rate	Increase peak current
	Improve dimensional accuracy by	Slow Cutting Rate
	Dimensional accuracy and SF quality	slow CR, 5.5 mm/min for NdFeB and 0.17 mm/min for MnZn ferrite
	Discharge current intensity, Pulse frequency, Pulse duration, Machine parameter, pulse duration, pulse frequency, dielectric flow rate effects on sparking frequency and the real-time regulation of the pulse off-time effects on	Surface roughness Material removal rate (MRR)

3.4 Wire parameters and control systems in WEDM

The occurrence of wire breakage during WEDM is one of the most undesirable machining characteristics greatly affecting the machining accuracy and performance together with the quality of the part produced. Many attempts have been made to develop an adaptive control system providing an online identification of any abnormal machining condition and a control strategy preventing the wire from breaking without compromising the various WEDM performance measures. A wide variety of the control strategies preventing the wire from breaking are built on the knowledge of the characteristics of wire breakage. Kinoshita et al. [36] observed the rapid rise in pulse frequency of the gap voltage, which continues for about 5–40 ms before the wire breaks. They developed a monitoring and control system that switches off the pulse generator and servo system preventing the wire from breaking but it affects the machining efficiency. Several researchers [37, 38] also suggested that the concentration of electrical discharges at a certain point of the wire which causes an increase in the localized temperature is resulting in the breakage of the wire. However, the adaptive control system concentrating on the detection of the sparking location and the reduction of the discharge energy was developed without making any considerations to the MRR. The breakage of the wire has also been linked to the rise in the number of short-circuit pulses lasting for more than 30 ms until the wire broke. Other authors [39] argued that the wire breakage is

correlated to the sudden increase in sparking frequency. It was also found that their proposed monitoring and control system based on the online analysis of the sparking frequency and the real-time regulation of the pulse off-time affect the MRR. Liao et al. [40] remedied the problem by relating the MRR to the machining parameters and using a new computer-aided pulse discrimination system based on the pulse train analysis to improve the machining speed. Whereas Yan and Liao [41, 42] applied a self-learning fuzzy control strategy not only to control the sparking frequency but also to maintain a high MRR by adjusting in real time the off-time pulse under a constant feed-rate machining condition. The breaking of the wire is also due to the excessive thermal load producing unwarranted heat on the wire electrode. Most of the thermal energy generated during the WEDM process is transferred to the wire while the rest is lost to the flushing fluid or radiation [39]. However, when the instantaneous energy rate exceeds a certain limit depending on the thermal properties of the wire material, the wire will break. Several authors [43, 44] and [45] investigated the influence of the various machining parameters on the thermal load of the wire and developed a thermal model simulating the WEDM process.

4. A knowledge based system for WEDM

A KBS for WEDM has been developed in a computer based CE environment, the third version of an expert system shell (NEXPERT), based on object-oriented techniques (OOT). A Hewlett Packard (HP) workstation was used in development of the expert system. A geometric specification of design feature and material type of the work piece are sent for manufacturability evaluation at the various stages in its design. Within the manufacturability procedure, the machining time and cost of producing part are estimated. The labour and depreciation cost of WEDM for each selected design feature specification are estimated. Also various machining parameters are estimated. The material specifications are described in terms of its depth, width and its melting point etc. The attributes of different material types of wire-electrode materials, one type of dielectric solution, and different types and sizes of WEDM machine are stored in working memory or data-bases. The KBS can retrieve information from working memory and advise the designer on the appropriate choice of material, for wire-tool and material type of work piece, dielectric solution and machine capacity. The KBS also contains information related to good practice rules, machine, process capabilities, and constraints. For the present KBS, knowledge has been gathered from literature and talking with expert and experimental results on WEDM. For each selected design feature undergoing evaluation for its manufacturability by WEDM, the cost of the machine cycle is estimated from those costs for WEDM machine tool depreciation, labour, and machining cost. Machine cycle time is also a key factor, which depends for example on setting-up of wire in the machine, loading and unloading of work-piece, inspection of wire and component, their cleaning, and general maintenance. Assessment of the manufacturability of a work piece material, usually from machining cycle time and cost, is established automatically by the KBS. This KBS can advise on the production of each work piece material. From this information, the process variables can be selected that best balances between the required qualities against efficiency of manufacturing.

5. Architecture of IKBS for WEDM

The IKBS contains expertise gathered from both experiment and general knowledge about WEDM that can be provided to designers and manufacturing engineers. Architecture of wire-EDM is including the following module:

- Material (work piece) database: The material (work piece) database contains three different material types for work-piece which interactively are acquired by the IKBS for WEDM. Each of which can be produced by WEDM machine.
- Wire electrode-tool materials: Attributes of four different wire tool materials that can be accepted by the system are stored in the tool-material database.
- Dielectric solution: Properties of one main dielectric fluid, de ionizing waters stored, from which the expert system can deliver information on process conditions.
- WEDM machine characteristics: Information is contained on 3 different machine types of WEDM machines and their capital cost.
- Machining cycle time and cost module: The knowledge base provides estimates of cycle time and costs for each selected design feature based on the selected material type for wire tool, dielectric, and WEDM process conditions such as on-time, off-time, current.
- Manufacturability: The manufacturability is assessed by consideration of the work piece specification, the Wire--EDM production rate, efficiency and its effectiveness of the machine used in their production.

A flow chart of IKBS is presented in Figure 4 from which the following modules are noted.

6. Experiment verification

The IKBS system described above was compared with experimental WEDM machine. Results are presented in Table 1. These experiments have been carried out in WEDM machine. Two different types of environments are used to compare the results of experimental and KBS system which are demonstrated in Table 1 and 2. Deionised water is used as dielectric fluid. An attraction of the so developed knowledge based system is its capability to offer to product designers and manufacturing engineers, and to advice on machining cycle time, cost, production rate, efficiency and effectiveness of a particular WEDM operation for various machine. Critical components of the WEDM process are the wire and the dielectric water. Wire comes in several materials and a range of diameters, with 0.1 or 0.3 mm most commonly used. The wire used for most applications is made of brass. For higher performance, one might choose a zinc-coated wire for increased speed and improved surface finish. The zinc coating allows the wire to tolerate higher heat and helps keep the spark more consistent. Heat-diffused, annealed wire—brass wire enriched with zinc—can tolerate more heat in the cut. To wire EDM a thick part, which would not get much flushing water to the wire at the center of the work piece, you would use a high-performance wire. It could withstand the heat, maintain consistency throughout the cut and resist breakage. Today's EDM machines sense the wire and cutting conditions and adjust the cutting speed accordingly. "Just changing the wire can give you speed improvement, without making any other adjustments". In one application, for example, brass wire made a cut in 10 hours, but diffused annealed wire reduced that to seven hours, without changing any settings. The process could be optimized by adjusting settings on the machine. The improvement is very application dependent, "Some improve more, some less, but there's always a dramatic shift. Even 5 percent improvement can make it worthwhile." Any type of wire will cost only a few dollars per hour, and a high-performance wire can pay more than for itself in increased production. Other types of EDM wire are available for specific applications. Implantable medical devices, for example, must not encounter copper, so molybdenum wire is used. Break-resistant steel-core brass wire is used for applications where the wire is under high tension. Automatic wire

threads into 0.25 mm diameter wire with 0.7 mm hole. Figure 5 demonstrates automatic wire threading of a 0.25 mm diameter wire brass into a 0.7 mm hole. The product quality produced by the WEDM is always affected by the process parameters like the pulse on time, pulse off time, peak current, spark on time, arc off time, polarity, servo voltage, no load voltage, duty factor, dielectric, feed rate override, wire feed rate, wire tension and water pressure, etc. Table 4 lists the process factors that are used in this experiment (i.e., the pulse on time, pulse off time, spar voltage, wire feed rate, wire tension, water pressure).

Table4. Experimental factors

Control factor	units μ s
Pulse on time	0.3 μ s
Pulse off time	10 μ s
Spark off time	10 μ s
Spark on time	2 μ s
Servo voltage	40 V
Wire feed rate	8.0 m/min
Wire tension	1450 gf
Water pressure	10 kg/cm ²

The water: To get the best performance from a wire EDM machine, it is necessary to maintain the water’s cleanliness and correct conductivity. In the EDM process, some of the metal goes into the water as small particles and some gets dissolved in the water. The water re circulates through a two-part water treatment—a filter to remove particles and a deionizing waters-in to remove metal atoms from solution. Good maintenance input, output, constraint and features library and databases are used by Knowledge based System is demonstrated in Figure 4. The hardness of work piece material was 35 HRC. The chemical composition of work piece material is shown in Table 1.

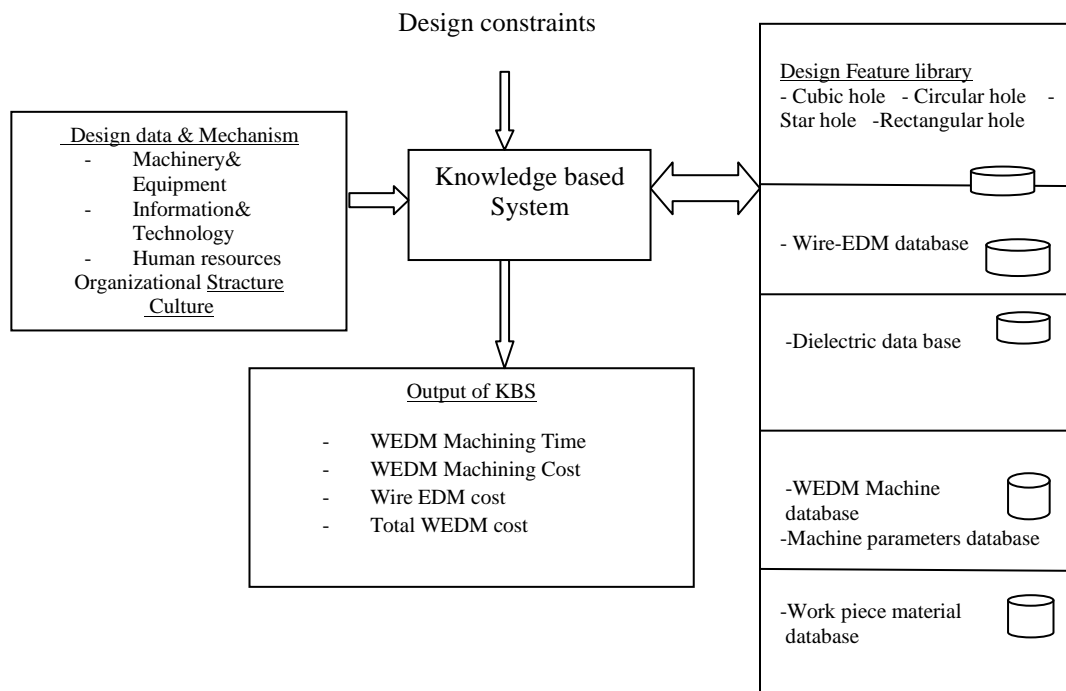

Figure4. Input, Output, constraint and databases of IKBS

Practice includes periodically replacing the filter cartridges and sending the deionizing resin out for generation. Figure 6 shows de ionizing water (left) and filtration columns on an Ebbco accessory filter system. Table 6 demonstrates comparison between experimental WEDM and Intelligent Knowledge based System for cubic and rectangular hole making in carbon steel material by WEDM. In Figure 5, schematic diagram of 0.25mm wire into a 0.7 mm hole is demonstrated.

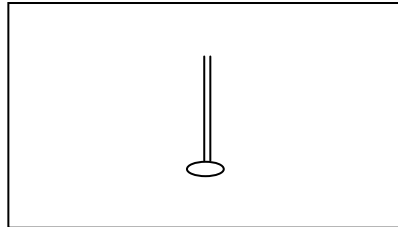

Figure5. Schematic diagram of 0.25mm wire into a 0.7 mm hole



Figure6. Process of de ionizing (left) and filtration system (right)

Table5. Parameters used in WEDM machine

WEDM	Work piece Material	Any conductive material like Carbon Steel, Aluminum, etc.
	Dielectric	Deionised water
	Wire tool diameters	Wire diameter 0.025-0.3 mm
	Wire-tool type of material	Wire material Brass, copper, tungsten
	Degree of taper ranging	from 15 for a 100 mm thickness to 30 for a 400 mm thickness on cut surface
	Gap between wire and work piece	0.025--0.05 mm
	Temperature of spark energy	12000 - 20000 centigrade
	Pulse frequency direct current	20000-30000 Hz
	Material removal rate	8 mm ³ /min
	Cutting rates(CRs)	300 mm ² /min for 50 mm thickness steel
	Machine (process) control following factors	Pulse duration, discharge frequency, Discharge current density, cutting rate
	Wire tool performance	Effect on MRR
	Wire vibration	Effect on accuracy and surface roughness, static deflection and geometry accuracy





Experimental results and intelligent knowledge base system results of WEDM are presented in Table 1. The results of expert system for WEDM for the same design feature (cubic and rectangular hole) are presented and compared with experimental one and is presented in table 1. The tool wire diameter is 0.25 mm and the depth of holes is 50mm. In practical WEDM, estimates of machining time and cost, cutting rate and material removal rate are time-demanding on experienced personnel. In contrast, the

knowledge-based system can provide these estimates usually in less than one minute. For example, the expert system result of a star hole, cubic hole, rectangular hole, hexagonal hole with different material type for work piece, dielectric ionised water and tool wire for the same design feature specification is presented in Table 2. Designers of manufacturing engineers select work piece material from database and design feature from feature library. Then work piece specification and design description for each selected design feature are obtained interactively by the IKBS. Machine parameters are selected from database. Also wire tool and deionise water specification are selected from databases. The system estimates of all necessary parameters including machining time and cost, material removal rate and efficiency are estimated by the IKBS. The system also recommends optimum use of parameters. Table 6 shows comparison of experimental WEDM and IKBS WEDM for cubic and rectangular hole making in carbon steel material. Table 7 demonstrates IKBS system result for different design feature holes for carbon steel material in WED.

7. Validity of the intelligent knowledge base system (IKBS)

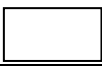

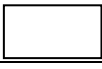



The intelligent knowledge base system (IKBS) for WEDM described above was compared with experimental one. Results are presented in Table 7. These experiments have been carried out on WEDM machine. Deionise water is used as dielectric fluid.

Table6. Comparison of experimental WEDM and IKBSWEDM for cubic and rectangular hole in carbon steel material
Dielectric fluid is deionized water. Wire type is brass with 0.25 mm Depth of cut is 50 mm

Design feature shape	Design feature type	Feature dimension (mm)	Procedure	Dielectric type	Surface roughness R_a (μm)	MRR mm^3/min	WEDM machining time (min)	WEDM cost US \$
	Rectangular hole	width 10, length 15	Experimental	Deionised water	10	7.25	120.0	8.0
	Cubic hole	width 10mm	Experimental	Deionised water	10	7.25	96.0	6.4
	Rectangular hole	width 10, length 15	Knowledge based system	Deionised water	5	8	109.38	7.29
	Cubic hole	width 10mm	Knowledge based system	Deionised water	5	8	87.5	5.83

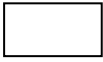
Brass wire is used as tool with 0.25 diameters. Table 8 demonstrated results of IKBS for different types of hole making by WEDM. An attraction of the so developed IKBS is its capability to offer to product designers and manufacturing engineers, and to advice on machining cycle time, cost, MRR, and surface roughness of a particular WEDM operation for various machine. The result of the IKBS is better than results of experimental one. For example experimental one show 120 minutes machining time for rectangular hole, But IKBS estimation is 109.30 min, which is improved and optimised 10 percent. Machining cost for rectangular hole is 8 US\$, But IKBS estimation is 7.29 US\$, which is approximately 10 percent less than experimental one. MRR in experimental one is $7.25\text{mm}^3/\text{min}$ But in IKBS is $8\text{mm}^3/\text{min}$, which is improved approximately 11 percent. The surface roughness in experimental one is $10\mu\text{m}$ but IKBS estimates $5\mu\text{m}$ similar results are obtained for cubic hole making by WEDM. For improvement and optimization of WEDM performance, designers and manufacturing engineers use advise of IKBS and optimize the WEDM performance.

Table 7. KBS system result of different design features for carbon steel material in WEDM

Design feature shape	Design feature type	Dielectric type	Wire type 0.25mm	Feature descriptions (mm)	Cutting rate mm^2/min	MRR mm^3/min	WEDM machining time (min)	WEDM cost US \$
	Circular hole	Deionised water	Brass	dia 10 mm	300	8	87.5	5.83
	Triangular hole	Deionised water	Brass	Edge 10 mm	300	8	65.6	4.37
	Rectangular hole	Deionised water	Brass	width 10, length 15	300	8	109.38	7.29
	Cubic hole	Deionised water	Brass	width 10mm	300	8	87.5	5.83
	Star hole 10 edge.	Deionised water	Brass	edge size 10 mm	300	8	218.75	14.58
	Hexagonal hole	Deionised water	Brass	edge 10 mm	300	8	131.25	13.12

8. Concluding remarks

The author has described concept of WEDM and its parameters and developed intelligent knowledge base system (IKBS) for WEDM. The IKBS system described above was compared with experimental WEDM machine. Results are presented in Table 7. These experiments have been carried out on WEDM machine. Deionised water is used as dielectric fluid. Brass wire is used as tool with 0.25 diameters. Table 8 demonstrated results of IKBS for different types of hole making by WEDM. An attraction of the IKBS so developed is its capability to offer to product designers and manufacturing engineers, and to advice on machining cycle time, cost, MRR, and surface roughness of a particular WEDM operation for various machines. WEDM is a well-established non-conventional material removal process capable of meeting the diverse machining requirements posed by the demanding metal cutting industries. It has been commonly applied for the machining and micro-machining of parts with intricate shapes and varying hardness requiring high profile accuracy and tight dimensional tolerances. However the main disadvantage of the process is the relatively low machining speed, as compared to the other non-traditional machining processes such as the laser-cutting process, largely due to its thermal machining technique. In addition, the development of newer and more exotic materials has challenged the viability of the WEDM process in the future manufacturing environment. Hence, continuous improvement needs to be made to the current WEDM traits in order to extend the machining capability and increase the machining productivity and efficiency. The ultimate goal of the WEDM process is to achieve an accurate and efficient machining operation without compromising the machining performance. The number of factors affecting the process has to be understood in order to determine the trends of the process variation. Material removal rate (MRR) depends on the following factors: A single parameter change will influence the process in a complex way, work piece material, dielectric fluid, machine characteristic, adjustment of machine parameters, component geometry, discharge current intensity,

pulse frequency and pulse duration. The cutting rate CR, MRR and SF are usually known as the measures of the process performance. Optimization of the WEDM process will remain a key research area matching the numerous process parameters with the performance measures. Several parameters in WEDM affect WEDM performance including:

1. Material removal rate (MRR) depends on sparking frequency and the real-time regulation of the pulse off-time, and pick current.
2. Surface roughness depends on discharge current intensity, Pulse frequency, Pulse duration, Machine parameter, pulse frequency, dielectric flow rate.
3. Increase wire tension would increase surface roughness.
4. Slow cutting rate improves surface roughness and dimensional accuracy.
5. Wire vibration affects accuracy and surface roughness, static deflection and geometry accuracy.
6. Selection of WEDM operating parameter is critical for operation of optimum cutting rate and material removal rate, surface roughness and accuracy.
7. Metrical inaccuracy of the WEDM part is the various process forces, acting on wire causing depart for the programmed path.
8. Process forces acting on accuracy and surface roughness, and static deflection and geometry accuracy
9. Increase wire tension increases surface roughness.
10. Surface roughness depends on discharge current intensity, Pulse frequency, Pulse duration, Machine parameter, pulse frequency, and dielectric flow rate.
11. Electro-static forces acting on the wire and the electro-dynamic forces accuracy and surface roughness, static effect and geometry accuracy
12. Static deflection in the form of a lag effect of the wire effects on produce an accurate cutting tool path
13. Dynamic behavior of the wire during WEDM avoids cutting inaccuracies.
14. When the wire and the wire guides are completely submerged in the working tank filled with deionised water, vibration of the wire is reduced.
15. Wire diameter affects cutting rate without changing any settings.
16. Wire breakage depends on controlling rapid rise in pulse frequency of the gap voltage 5-40 ms before the wire breaks. Using monitoring and control system switches off the pulse generator and servo system preventing, pulse frequency of the gap voltage
17. Concentration of electrical discharges at a certain point of the wire, which causes an increase in the localized temperature
18. Excessive thermal load produces no warranted heat on the wire electrode.
19. WEDM is a non-thermal process, which does rely on a conductive work piece and is preferable for machining of conductive work pieces material.
20. It is possible to any kind of hole making with any type of conductive material without causing geometrical inaccuracy and excessive surface integrity damage.
21. No major fatigue problems were encountered with the high-speed steel tool, any chipping/fracture generally being due to tool/hole misalignment during fabrication.
22. WEDM hole making caused no deformation of the work piece microstructure.
23. Increase gap would reduce discharge energy.

24. Machine (process) control following factors
25. Increasing peak current, water pressure, and machine control.
26. The number of geometric tool motion compensation methods affects sin creasing the machining gap and prevents gauging or wire breakages.
27. Wire lag affects geometrical inaccuracy of the WEDM part.
28. Increase pick current would increase surface roughness and material removal rate.
29. Slow cutting rate improves surface roughness and dimensional accuracy.
30. Wire tool performance affects material removal rate.

9. References

- [1] Guitrau, E. B. 1997. *The EDM Handbook*, Hanser Gardner Publications, Cincinnati.
- [2] Jameson, E. C. 2001. Description and development of electrical discharge machining (EDM). In: *Electrical Discharge Machining*, Society of Manufacturing Engineers, Dearborn, Michigan, 16.
- [3] Mohri, N., Fukuzawa, Y. and Tani, T. 2002. Some considerations to machining characteristics of insulating ceramics towards practical use in industry, *Ann. CIRP*, 51, 112–116.
- [4] Qu, J., Shih, A. and Scattergood, R. 2002. Development of the cylindrical wire electrical discharge machining process: Part 1. Concept, design, and material removal rate, *Trans. ASME*, 124, 702–707.
- [5] Weng, F. and Her, M. 2002. Study of the batch production of micro parts using the EDM process, *Int. J. Adv. Manuf. Technol.*, 19, 266–270.
- [6] Yeo, S. and Yap, G. 2001. A feasibility study on the micro electro-discharge machining process for photo mask fabrication, *Int. J. Adv. Manuf. Technol.*, 18, 7–11.
- [7] Huang, Y. H., Zhao, G. G., Zhang Z. R. and Yu, C. Y. 1986. The identification and its means of servo feed adaptive control system in WEDM, *CIRP Ann. Manuf. Technol.*, 35(1), 121–123.
- [8] Kozak, J. K., Rajurkar, P. and Wang, S. Z. 2002. Material removal in WEDM of PCD blanks, *Trans. ASME, J. Eng. Ind.*, 116, 363–369.
- [9] Puertas, I. and Luis, C. J. 2003. Modeling the manufacturing parameters in electrical discharge machining of siliconized silicon carbide, *Proc. Inst. Mech., J. Eng. Manuf.*, 217(Part B), 791–803.
- [10] Mohri, N., Fukusima, Y., Tani T. and Saito, N. 2003. Layer generation process on work piece in electrical discharge machining, *Ann. CIR*, 53, 81–87.
- [11] Ho, K. H. and Newman, S. T. 2003. State of the art electrical discharge machining (EDM), *Int. J. Mach. Tools Manuf.*, 43(13), 1287–1300.
- [12] Puri, A. B. and Bhattacharyya, B. 2003. An analysis and optimization of the geometrical inaccuracy due to wire lag phenomenon in WEDM, *Int. J. Mach. Tools Manuf.*, 43(2), 151–159.
- [13] Shobert, E. I. 1983. What happens in EDM. In: E.C. Jameson, Editor, *Electrical Discharge Machining: Tooling, Methods and Applications*, Society of Manufacturing Engineers, Dearborn, Michigan, 3–4.
- [14] Tsai, H. C. Yan, B. H. and Huang, F. Y. 2003. EDM performance of Cr/Cu-based composite electrodes, *Int. J. Mach. Tools Manuf.*, 43(3), 245–252.
- [15] McGeough, J. A. 1988. *Electrodes charge machining* In: *Advanced Methods of Machining*, Chapman & Hall, London, 130.
- [16] Krar, S. F. and Check, A. F. 1997. *Electrical discharge machining* In: *Technology of Machine Tools*, Glencoe/McGraw-Hill, New York, 800.
- [17] Benedict, G. F. 1987. *Electrical discharge machining (EDM)*. In: *Non-Traditional Manufacturing Processes*, Marcel Dekker, Inc, New York & Basel, 231–232.

- [18] Kunieda, M. and Furudate, C. 2001. High precision finish cutting by dry WEDM. *Ann. CIRP*, 50(1), 121–124.
- [19] Huntress, E. A. 1978. Electrical discharge machining, *Am. Machinist*, 122(8), 83–98.
- [20] Qu, J., Shih, A. J. and Scattergood, R. O. 2002. Development of the cylindrical wire electrical discharge machining process, part 1: concept, design, and material removal rate, *J. Manuf. Sci. Eng.*, 124(3), 702–707.
- [21] Rhoney, B. K., Shih, A. J., Scattergood, R. O., Akemon, J. L., Gust D. J. and Grant, M. B. 2002. Wire electrical discharge machining of metal bond diamond wheels for ceramic grinding, *Inter. J. Mach. Tools Manuf.*, 42(12), 1355–1362.
- [22] Qu, J., Shih, A. J. and Scattergood, R. O. 2002. Development of the cylindrical wire electrical discharge machining process, part 2: surface integrity and roundness. *J. Manuf. Sci. Eng.* 124(3), 708–714.
- [23] Konda, R., Rajurkar, K. P., Bishu, R. R., Guha, A. and Parson, M. 1999. Design of experiments to study and optimize process performance, *Inter. J. Qual. Reliab. Manage*, 16(1), 56–71.
- [24] Tarng, Y. S., Ma, S. C. and Chung, L. K. 1995. Determination of optimal cutting parameters in wire electrical discharge machining *Inter. J. Mach. Tools Manuf.*, 35(12), 1693–1701.
- [25] Huang, J. T., Liao, Y. S. and Hsue, D. W. J. 1999, Determination of finish-cutting operation number and machining-parameters setting in wire electrical discharge machining, *J. Mater. Process. Technol.*, 87(1–3), 69–81.
- [26] Scott, D., Boyina, S. and Rajurkar, K. P. 1991. Analysis and optimization of parameter combination in wire electrical discharge machining, *Inter. J. Prod. Res.*, 29(11), 2189–2207.
- [27] Liao, Y. S., Huang, J. T. and Su, H. C. 1997. A study on the machining parameters optimization of wire electrical discharge machining, *J. Mater. Process. Technol.*, 71(3), 487–493.
- [28] Rozenek, M., Kozak, J., Dabrowski, L. and Lubkowski, K. 2001. Electrical discharge machining characteristics of metal matrix composites, *J. Mater. Process. Technol.*, 109(3), 367–370.
- [29] Huang, J. T. and Liao, Y. S. 2003. Optimization of machining parameters of WEDM based on grey relational and statistical analyses. *Inter. J. Prod. Res.*, 41(8), 1707–1720.
- [30] Rajurkar, K. P. and Wang, W. M. 1993. Thermal modeling and on-line monitoring of WEDM., *J. Mater. Process. Technol.*, 38(1–2), 417–430.
- [31] Gökler, M. I. and Ozanözgü, A. M. 2000. Experimental investigation of effects of cutting parameters on surface roughness in the WEDM process, *Inter. J. Mach. Tools Manuf.*, 40(13), 1831–1848.
- [32] Tosun, N., Cogun, C. and Inan, A. 2003. The effect of cutting parameters on work piece surface roughness in wire EDM. *Machining Sci. Technol.*, 7(2), 209–219.
- [33] Anand, K. N. 1996. Development of process technology in wire-cut operation for improving machining quality, *Total Quality Management*, 7(1), 11–28.
- [34] Spedding, T. A. and Wang, Z. Q. 1997. Parametric optimization and surface characterization of wire electrical discharge machining process, *Precision Eng.*, 20(1), 5–15.
- [35] Williams, R. E. and Rajurkar, K. P. 1991. Study of wire electrical discharge machined surface characteristics, *J. Mater. Process. Technol.*, 28(1–2), 127–138.
- [36] Kinoshita, N., Fukui, M. and Gamo, G. 1982. Control of wire-EDM preventing electrode from breaking, *Ann. CIRP*, 31(1), 111–114.
- [37] Shoda, K., Kaneko, Y., Nishimura, H., Kunieda, M. and Fan., M. X. 1992. In: *Adaptive Control of WEDM with On-line Detection of Spark Locations*.
- [38] Kunieda, M., Kojima, H. and Kinoshita, N. 1990. On-line detection of EDM spark location by multiple connection of branched electric wires, *Ann. CIRP*, 39(1), 171–174.

- [39] Tanimura, T., Heuvelman, C. J, and Vennstra, P. C. 1977. The properties of the servo gap sensor with wire spark-erosion machining, *Ann. CIRP*, 26(1), 59–63.
- [40] Liao, Y. S., Chu, Y. Y. and Yan, M. T. 1997. Study of wire breaking process and monitoring of WEDM, *Inter. J. Mach. Tools Manuf.*, 37(4), 555–567.
- [41] Yan, M. T. and Liao, Y. S. 1996. Monitoring and self-learning fuzzy control for wire rupture prevention in wire electrical discharge machining, *Inter. J. Mach. Tools Manuf.*, 36(3), 339–353.
- [42] Yan, M. T. and Liao, Y. S. 1996. A self-learning fuzzy controller for wire rupture prevention in WEDM, *Inter. J. Adv. Manuf. Technol.*, 11(4), 267–275.
- [43] Jennes, M., Dekeyser, W. and Snoeys, R. 1984. Comparison of various approaches to model the thermal load on the EDM-wire electrode, *Ann. CIRP*, 33(1), 93–98.
- [44] Obara H., Iwata Y., Ohsumi T. 1995. An attempt to detect wire temperature distribution during wire EDM, *Proc. ISEM XI, Lozanna*, 67-73.
- [45] Performance in EDM wire cutting, *J. Manuf. Syst.*, 4(2), 179–190.